

Lynx Plus Series Control

Quick Installation Guide

This Quick Installation Guide can help you install the rechargeable Lynx Plus Series Control quickly and easily by providing the basic steps for installation using the built-in defaults and the Voice Prompt Programming mode. The Voice Prompt Programming mode allows you to quickly program the system by responding to a series of voice prompts.

FOR DOCUMENTATION AND ONLINE SUPPORT: <http://www.security.honeywell.com/hsc/resources/MyWebTech>
(see Lynx Plus Series Installation and Setup Guide P/N 800-03857 or higher)

WARRANTY INFORMATION

For the latest warranty information, please go to:
www.honeywell.com/security/hsc/resources/wa

1. Install the Control

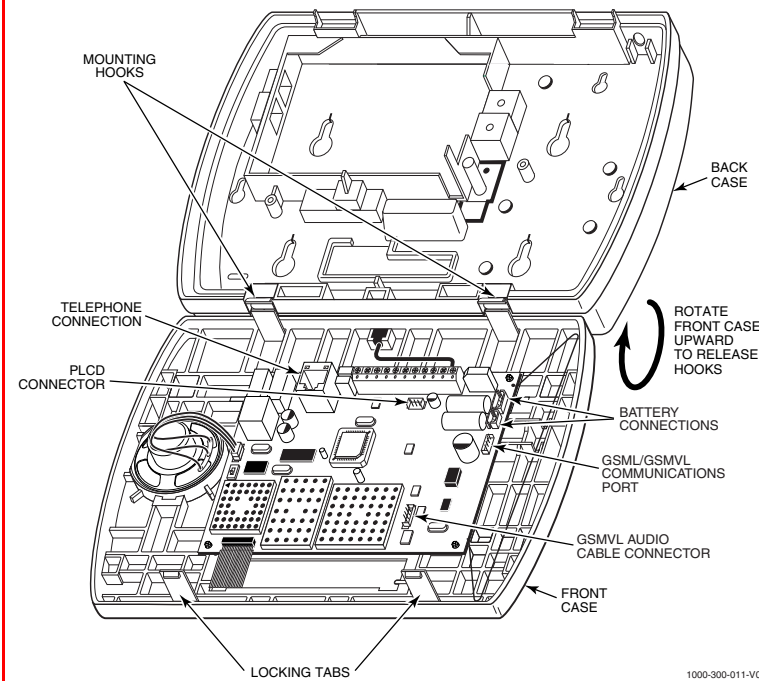

1. Separate the front case from the rear case by rotating the front case and releasing the hooks from the rear case.
2. Feed the wiring through the openings provided in the rear case.
3. Mount the rear case to a sturdy wall and secure with the provided screws.
3. Reconnect the front case and rear case.

2. Make Wiring Connections

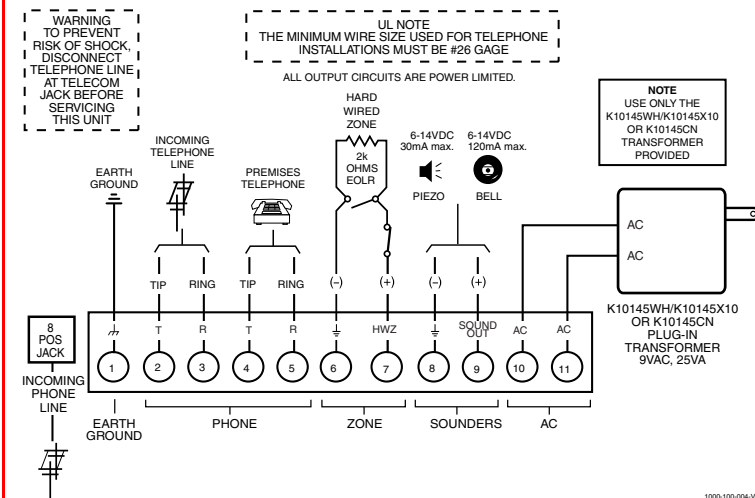

Note: For the complete Summary of Connections, refer to the Lynx Plus Series Installation and Setup Guide P/N 800-03857 or higher

1. Make earth ground connections to terminal 1.
2. Connect the incoming phone line to either the 8-position jack or terminals 2 (TIP) and 3 (RING).
3. Connect the handset phone lines to terminals 4 (TIP) and 5 (RING).
3. **Note:** For full line seize operation, refer to the Lynx Plus Series Installation and Setup Guide.
4. If used, connect a piezo sounder or bell to terminals 8 (-) and 9 (+).
5. Connect the sensors/contacts to the hardwired zone terminals 6 (-) and 7 (+).
6. If used, connect the GSML or GSMVL communications device to the GSML/GSMVL communications port.
7. Connect wires from the K10145WH/K10145 OR K10145CN Transformer to terminals 10 and 11.

Note: If using Powerline Carrier Devices refer to the Lynx Plus Series Installation Guide P/N 800-03857 or higher.

3. Make Battery Connections

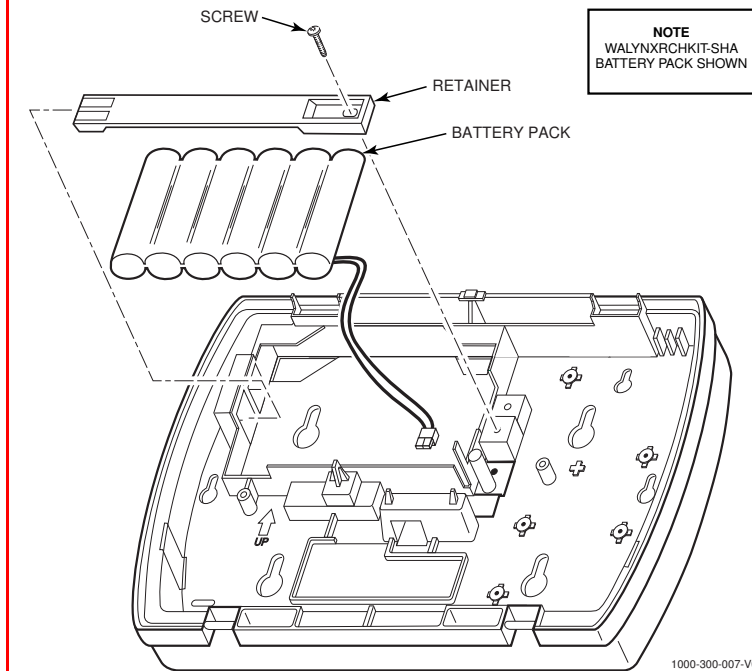

1. Remove screw securing the battery retainer.
 2. Remove the battery retainer.
 3. Insert battery pack into back plate.
 4. Install battery retainer.
 5. Install screw to secure the battery retainer.
 6. Connect battery connector to receptacle on PC board.
 7. After all wiring connections have been made, snap the front assembly to the back plate so it is held by the locking tabs.
 8. Plug the transformer into a 24-hour, 110VAC unswitched outlet.
- Note:** Rechargeable batteries may take up to 48-hours to fully charge. "LOW BAT" message should clear within four hours, or by entering Test Mode.

4. Program the Control

Change the Installer Code

The factory default Installer Code for the Lynx Plus Series Control is set to 4-1-1-2. To change this code, you must enter Expert Programming mode.

1. After Power-up, enter Installer Code + 8 0 0 or press both the [*] and [#] simultaneously within 50 seconds after power is applied to the control. The system will enter the Expert Programming Mode and "20 INSTALLER CODE" will be displayed.

Note: Upon power-up or after exiting program mode, the system takes up to a minute to reset. To bypass the reset delay, enter [#] + [0].

2. Enter *20
3. Enter a new four-digit Installer Code.

Program variable data fields

1. If required, enter *24 to program the desired 2-digit RF House ID for wireless keypads.
2. If required, enter *40 to program a PABX Access Code or to Disable Call Waiting (LynxSIA Plus only).
3. Enter *94 to program the downloading computer phone number.
4. Press the ESCAPE/OFF key to enter Voice Prompt Program mode. The system will announce, "Programming, use arrowsto scroll choices, press select to accept, press escape to quit." The system will announce the available options.

5. Follow the directions provided by each voice prompt to make your selections.

6. When you have completed each programming procedure the system will return to the Main Programming Menu.
- The FUNCTION/# key can be used to repeat a voice prompt, as required.

Viewing data fields

1. To view data entered in field, press [#] plus the field that you wish to view (e.g., #21). The system will beep three times and data programmed for that field will be displayed to the right of the field number. The system will scroll through the data for longer numbers and a beep will sound after each number is displayed or three times after the final digit is displayed.

(Continued on reverse side)



800-03860 9/09 Rev. A

Honeywell

2 Corporate Center Drive, Suite 100
P.O. Box 9040, Melville, NY 11747

Copyright © 2009 Honeywell International Inc.

www.honeywell.com/security

Programming Notes

Entering Voice Prompt Programming

Power-up the control and enter the Installer Code + 8 8 8. When you have completed each programming procedure the system will return to the Main Programming Menu.

Exiting Voice Prompt Programming

Once you have returned to the Main Programming Menu, press the **ESCAPE/ [OFF]** key.

Entering Central Station Phone Numbers

Enter 0-9, #+11 = *, #+12 = #, #+13 = a pause of 2 seconds.

Entering Central Station Account Numbers

Enter 0-9, #+11=B, #+12 =C, #+13=D, #+14=E, #+15=F

Programming Zone Types

The Voice Prompt Programming feature can not be used to program Zone Types 02, 05, 10, 14, and 24. Programming these zone types must be done using the Expert Programming Mode.

5. Voice Prompt Programming

Navigating the Voice Prompt Programming Mode

Scroll through the voice menu and follow the instructions provided to continue using the Voice Prompt Programming Mode.

The following keys are used to navigate through this feature.

- ESCAPE/ [OFF]** key: Used at any time to exit the current menu and return to the previous prompt.
- ADD/ [AWAY]** key: Used to add sensors or keys or save data when entering phone or account numbers.
- DELETE/ [STAY]** key: Used to delete a sensor when in the delete Sensors Menu.
- SELECT/ [AUX]** key: Used to confirm a selection.
- 3 ↑** key: Used to scroll forward through menu choices.
- 6 ↓** key: Used to scroll backward through menu choices.
- FUNCTION/ [#]** key: Used to repeat a voice prompt. (This function cannot be used while entering phone or account numbers.)

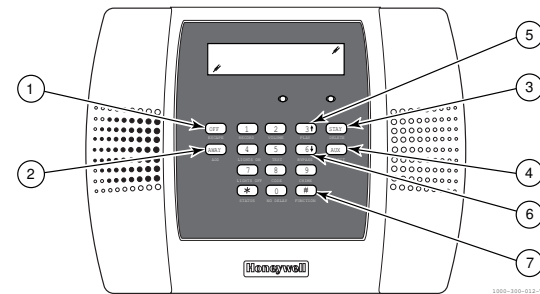

6a. Add Sensors



The Lynx Plus Series will enroll a sensor once the transmitter has been activated two times. The system will confirm the enrollment following each subsequent activation of the same transmitter.

Add a Door Sensor

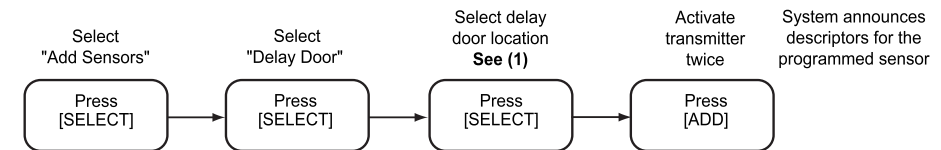

(1) Delay Door Location

Front Sliding Back Hall Side Kitchen Garage Patio Basement

Add a Window, Motion Detector, or Fire Detection Sensor

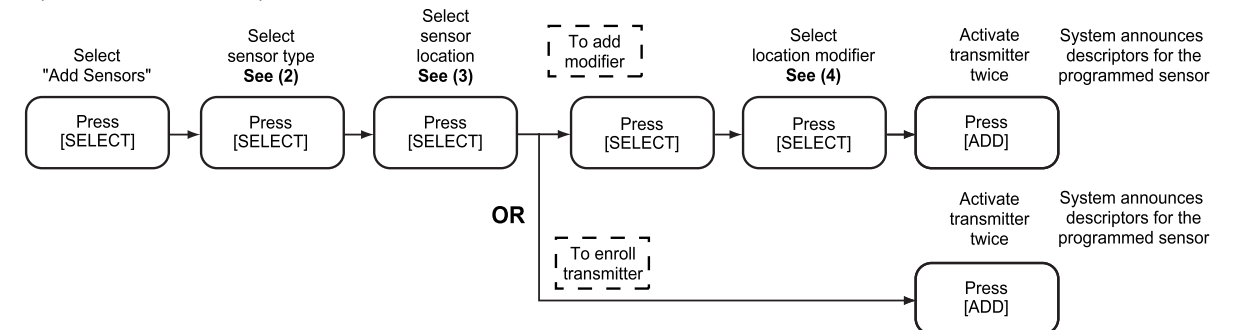

(2) Sensor Type

Window
Motion Detector
Fire Detection

(3) Sensor Location

Living room Kitchen
Dining room Hall
Bedroom Basement
Bathroom Master Bedroom
Nursery Den

(4) Location Modifiers

Family Room Attic Upstairs Second Floor
Guest Room Office Downstairs Front
Laundry Room Upstairs First Rear
Utility Room Second Second Side
Garage Third

6a. Add Sensors (Continued)

Add an Emergency Pendant

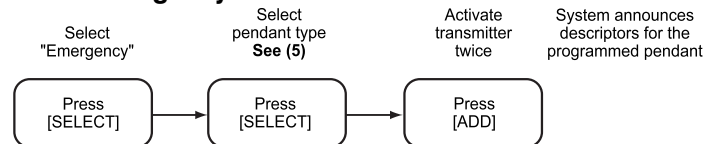

(5) Pendant Type

Medical Fire Silent Police Police

Add a Wireless Key



When adding wireless keys, wait 5 seconds between transmissions.

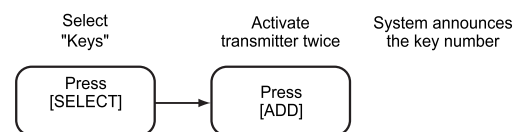

6b. Delete Sensors

Delete Sensors

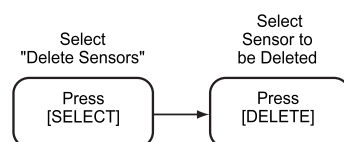

7. Add Central Station Accounts

Add First Central Station Phone Number

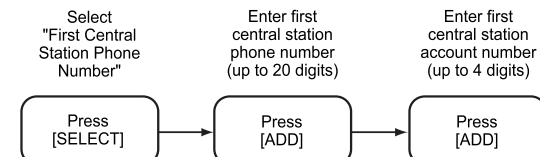

Add First Central Station Account Number



All four digits of the Central Station Account numbers must be entered. For ten-digit format, all ten digits must be entered. Refer to the Lynx Plus Series Installation and Setup Guide for additional information regarding these programming options.

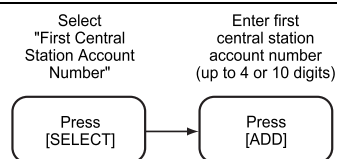

Add Second Central Station Phone Number

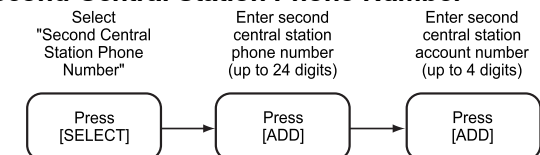

Add Second Central Station Account Number

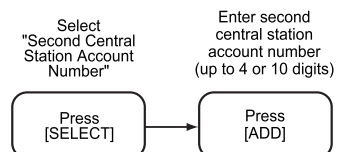

8. Program Additional Options

Enter Expert Programming Mode



Once you have entered the Expert Programming Mode, the [ESCAPE] key can be used to return to the Voice Prompt Programming mode. If you are in any of the Interactive Menu Modes (*56, *80, *81, *83, *84 or *85), you must return to the main menu in that field before pressing the [ESCAPE] key.

The Lynx Plus Series is configured with Factory Default Settings. You can revise these settings using the Expert Programming Mode. Refer to the Installation and Setup Guide to view these defaults and to continue programming the individual fields using this mode.

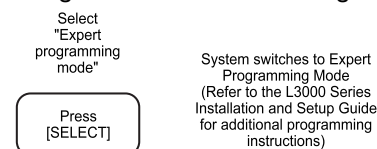

Exit Expert Programming Mode

When programming is complete, enter *99.

9. Perform Go/No Go Test

Temporarily mount wireless devices in the preferred mounting location and perform a Go/No Go test to ensure adequate signal strength is available.

- Enter Installer Code + [#] + [8] and run Go/No Go Test.
- Fault each transmitter to ensure all programmed zones are received.
- Mount the transmitter in its permanent location.

10. Program User Functions

Set the Real-Time Clock

- Enter the Installer Code + **FUNCTION/ [#]** + 63
- Follow the Voice Prompts to program the Clock/Calendar.

Change the Master User Code

- Enter the Installer Code + **CODE/ [8]** + 02 + desired 4-digit Master Code.

Add User Codes

- By following the procedures in the Lynx Plus Series User Guide, show the User how to add additional User Codes.

11. Test the system

- Enter the User Code + **TEST** key. The external sounder will sound for two seconds and all the LCD segments on the keypad display light for 3 seconds.
- Open each protected door and listen for three beeps from the keypad, followed by the zone's Voice Descriptor. Identification of each faulted protection point should appear on the display, and clear when the door is closed.
- Walk in front of the motion sensor and listen for three beeps and the zone's voice descriptor.
- When testing is complete, enter: User Code + **[OFF]** key.
- Press each key on the key fob to confirm it performs its assigned function.

Note: Refer to the Lynx Plus Series User Guide for additional information.